

Mehr Produkte finden Sie
in unserem Katalog!

Art. 714 200



Geräteschrank 20-A

20 mm / 80x85 cm / 0,68 m²

DIMENSIONEN

	Bohlenstärke	20 mm
	Innenmaß	76x81 cm
	Sockelmaß	80x85 cm
	Gesamtmaß	85x95 cm
	Grundfläche	0,68 m ²
	Rauminhalt	1,3 m ³
	Wandhöhe vorne (A) / hinten (B) vorne hinten	178 cm 201 cm
	Dachüberstand vorne seitlich hinten	8 cm 3 cm 8 cm

DACH

	Dachneigung	12°
	Dachfläche	1,0 m ²
	Dachbretter inkl. Dachpappe	20 mm

TÜR/ FENSTER

	Einzeltür (Vollholz)	73x158,5 cm
--	----------------------	-------------

FUSSBODEN

	Fußbodenbretter	20 mm
--	-----------------	-------

VERPACKUNG

	Paketabmessung	195x93x43 cm
	Paketgewicht	120 kg

ZUBEHÖR (zzgl.)

	Dachschildel-Set Nr. 1 1 Rolle Dichtungsbahn Einlegeboden
--	---

5 JAHRE
GARANTIE



Grundriss

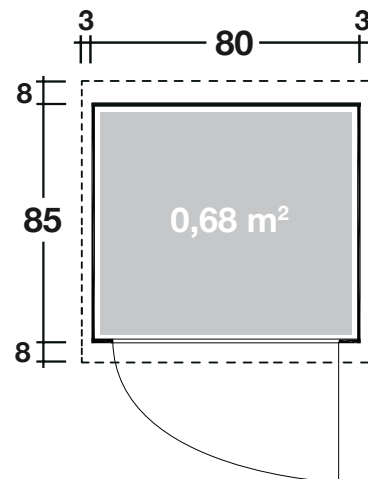

Weitere Informationen finden Sie unter: www.finnhaus.de oder im aktuellen Katalog.
Technische Änderungen, Druckfehler und Irrtümer vorbehalten.