

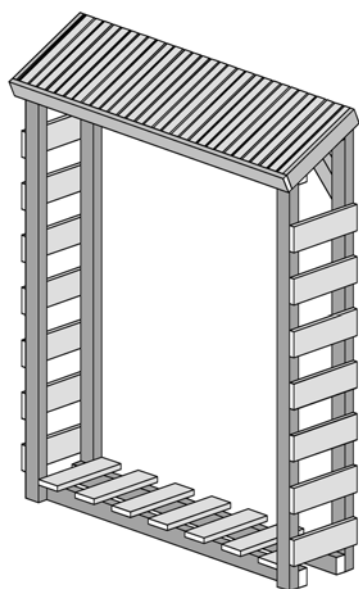

Montage-, Bedienungs- und Wartungsanleitung

en	ASSEMBLY, USER AND MAINTENANCE INSTRUCTIONS
fr	NOTICE DE MONTAGE, D'UTILISATION ET D'ENTRETIEN
it	ISTRUZIONI DI MONTAGGIO, USO E MANUTENZIONE



Art.-Nr.: 663.1303.00.00

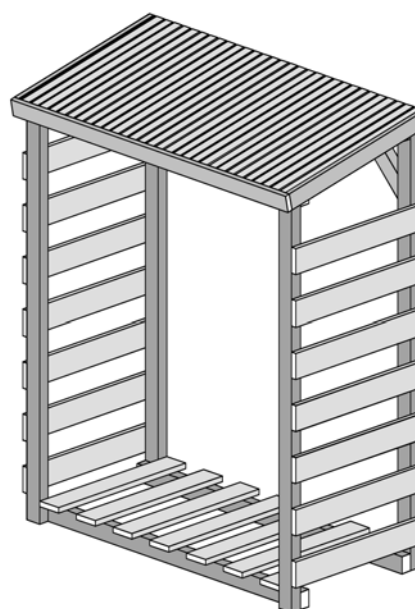

Art.-Nr.: 663.1306.00.00

Kaminholzlager

- de -

Sehr geehrte Kundin, sehr geehrter Kunde,

- Lesen Sie diese Anleitung vor dem Aufbau bitte vollständig durch, um Montagefehler oder Beschädigungen zu vermeiden.
- **WICHTIG !**
Prüfen Sie bitte sofort anhand der Packliste, ob das Produkt vollständig und unbeschädigt bei Ihnen angekommen ist.
- Bitte vernichten Sie die Packliste erst nach Ablauf der Garantiezeit. Diese Liste dient Ihnen zur Kontrolle auf Vollständigkeit der Einzelteile und ist mit dem Kaufbeleg aufzubewahren. Eventuelle Beanstandungen können mit Hilfe dieser Liste problemlos behoben werden. Die Pos.-Nummern der Packliste stimmen nicht mit den Pos.-Nummern folgender Montageanleitung überein.
- Wir empfehlen Ihnen die Montage mit 2 Personen durchzuführen.
- Zur Verhütung von Unfällen ist zu vermeiden, daß sich Kinder während der Montage in unmittelbarer Nähe befinden.
- Je nach Untergrund ist eine geeignete Befestigungsart zu wählen. (Befestigungsmittel nicht im Lieferumfang enthalten.)
- Weiterentwicklungen im Sinne des technischen Fortschritts behalten wir uns vor. So können geringfügige Abweichungen in den Darstellungen entstehen.
- Verpackungsmaterial nicht einfach wegwerfen! Papier-, Pappe- und Wellpappeverpackungen, sowie Kunststoffverpackungsteile sollten in die entsprechenden Sammelbehälter gegeben werden.

EMPFEHLUNGEN

- Bitte bohren Sie alle Schraubverbindungen vor, um Beschädigungen an den Holzteilen zu vermeiden! Folgendes Zeichen macht Sie während der Anleitung nochmals darauf aufmerksam:



- Holz ist ein Naturprodukt. Verschiedenartige Färbungen, Äste und Rißbildung sind normal und haben keinen Einfluß auf die Statik.

HOLZSCHUTZ

Um auch nach Jahren den optisch hochwertigen Eindruck Ihres weka-Produktes zu gewährleisten, empfehlen wir Ihnen, innerhalb eines Jahres nach Aufbau einen Schutzanstrich. Dieser Schutzanstrich dient der Verbesserung des äußeren Erscheinungsbildes, welches durch natürliche Bewitterung wie Sonneneinstrahlung und Regen in Mitleidenschaft gezogen wird.

Aus diesem Grund ist ein regelmäßiger Anstrich gemäß den Herstellerangaben der Holzschutzlasur zum Schutz des Holzes notwendig.

WERKZEUG

Folgendes Werkzeug sollten Sie vor Beginn der Montage zurecht gelegt haben.
(Nicht im Lieferumfang enthalten!)

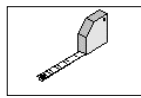

Bandmaß

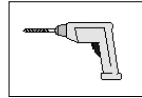

Bohrmaschine



Elektroschrauber

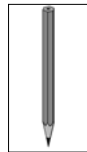

Bleistift



Wasserwaage

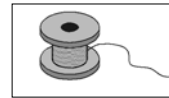

Schnur

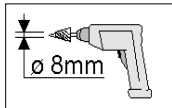

Kegelbohrer

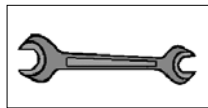

Schraubschüssel

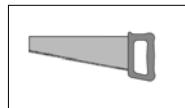

Säge

HINWEIS

In regelmäßigen Abständen sollten die Verschraubungen überprüft und nachgezogen werden. Dieses Produkt ist überwiegend aus Massivholz gefertigt und da es sich bei dem Werkstoff Holz um ein Naturprodukt handelt, kann es vorkommen, dass durch extreme Witterungseinflüsse, insbesondere nach langen Wärmeperioden, sich Trockenrisse bilden. Diese Trockenrisse sind keinesfalls ein Qualitätsmangel, sondern eine natürliche Erscheinung und je nach Wetterlage können sich diese Risse bis auf ein Minimum wieder verschließen.

Darüber hinaus haben diese Trockenrisse, welche in Längsrichtung des Holzes auftreten, keinen Einfluss auf die Festigkeit und Belastbarkeit des Materials. Das heißt, die statischen Eigenschaften werden nicht beeinträchtigt.

- en -

Dear customer

- Read these instructions through completely before assembling your product in order to avoid errors in assembly or damage.
- **IMPORTANT**
Please use the enclosed packing list to check immediately that your product has been delivered complete and intact.
- Please do not dispose of the packing list before the guarantee period has expired. This list enables you to check that all the individual parts are present. It should be retained along with the proof of purchase. Any complaints which may arise can probably be easily rectified with this list. The item numbers on the packing list do not correspond to the item numbers in the following assembly instructions.
- We recommend that 2 people carry out the assembly.
- In order to prevent accidents, we recommend that children are kept out of the direct vicinity during assembly.
- A suitable means of fixing the screwable anchors is to be selected depending on the substrate. (Fasteners are not included in the delivery.)
- We reserve the right to make further technological developments. This means that there may be minor deviations in the illustrations.
- Please do not simply throw away the packaging material. Paper, card and corrugated board as well as plastic packaging materials should be placed in the correct collection containers.

RECOMMENDATIONS

- Please drill pilot holes for all screw connections to avoid damaging the wood. The following symbol in the instructions will indicate when this is necessary:



- Wood is a natural product. Fluctuations in colour, knots and cracks are normal and have no influence on the statics.

Wood protection

In order to ensure that your weka product continues to look fantastic for years to come, we recommend that you apply a protective coating within a year of construction.

This protective coat improves the external appearance which may be detrimentally affected by natural weathering such as sun and rain.

This requires regular application in accordance with the instructions of the manufacturer of the wood protection scumble.

TOOL

You should have the following tools to hand before beginning assembly.

Not supplied.

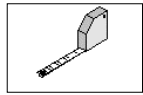

measuring tape

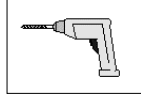

Drill



Electric screwdriver

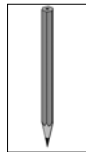

Pencil



Spirit level

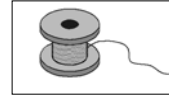

Cord

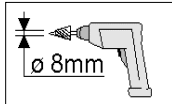

Taper drill

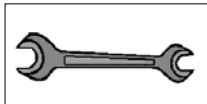

Spanner

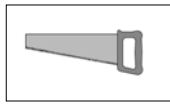

Saw

Il est conseillé de vérifier et de resserrer les assemblages vissés à intervalles réguliers. Ce produit est essentiellement fabriqué en bois massif. Le bois étant un matériau naturel, il se peut que des conditions climatiques extrêmes, notamment après de longues périodes de chaleur, entraînent la formation de fentes de sécheresse. Ces fentes de sécheresse ne constituent en aucun cas un défaut de qualité, mais un phénomène naturel. Selon la situation météorologique, ces fentes peuvent se refermer quasi-intégralement. De plus, ces fentes de sécheresse, qui apparaissent dans le bois dans le sens de la longueur, n'exercent aucune influence sur la solidité et la résistance du matériau. Autrement dit, les propriétés statiques ne sont pas affectées.

- fr -

Chère Cliente, cher Client

- Lisez entièrement la présente notice avant de procéder à l'assemblage afin d'éviter les erreurs et les dommages.
- **IMPORTANT !**
Veillez vérifier immédiatement, à l'aide de la liste des pièces, si le produit est arrivé complet et en bon état.
- Ne détruisez la liste des pièces qu'une fois la garantie écoulee. Cette liste vous permet de vérifier si les pièces détachées sont complètes et doit être conservée avec le justificatif d'achat. Elle vous permettra de faire valoir aisément d'éventuelles réclamations. Les numéros de pos. de la liste des pièces ne sont pas identiques aux numéros de pos. de la présente notice de montage.
- Nous vous recommandons d'effectuer le montage à 2 personnes.
- Afin de prévenir tout accident, éviter la présence d'enfants à proximité durant le montage.
- Choisir un mode de fixation des éléments d'ancrage adapté au support (le matériel de fixation n'est pas fourni).
- Nous nous réservons le droit d'apporter aux produits des modifications dans le cadre de l'évolution technique. De légères différences sont par conséquent possibles par rapport aux illustrations.
- Ne pas jeter simplement le matériel d'emballage! Les emballages en papier, carton et carton ondulé doivent être déposés dans le container de tri correspondant.

RECOMMANDATIONS

- Pré-percez tous les assemblages vissés afin d'éviter d'endommager les éléments en bois! Ceci vous est rappelé par le symbole suivant dans la notice:



- Le bois est un produit naturel. Les différentes colorations, les nœuds et les fissures sont normaux et n'ont aucun effet sur la tenue statique.

Protection du bois

Pour que votre produit weka conserve son bel aspect des années durant, nous vous recommandons d'appliquer une couche de protection dans l'année qui suit la pose. Cette couche de protection améliore l'aspect visuel qui pâtit de l'exposition naturelle au soleil et à la pluie. Il est donc indispensable d'appliquer régulièrement une couche de protection en observant les indications données par le fabricant du vernis protecteur.

OUTIL

Pour le montage, nous vous recommandons de préparer les outils suivants.

N'est pas compris dans la fourniture !

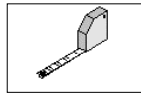

décamètre à ruban

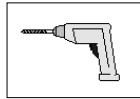

perceuse



visseuse électrique

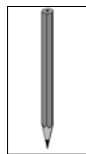

Crayon



Niveau à bulle

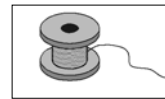

ficelle

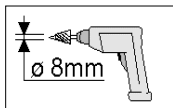

alésoir conique

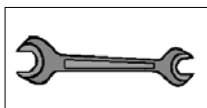

clé

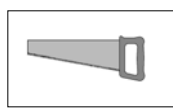

Scie

Il est conseillé de vérifier et de resserrer les assemblages vissés à intervalles réguliers. Ce produit est essentiellement fabriqué en bois massif. Le bois étant un matériau naturel, il se peut que des conditions climatiques extrêmes, notamment après de longues périodes de chaleur, entraînent la formation de fentes de sécheresse. Ces fentes de sécheresse ne constituent en aucun cas un défaut de qualité, mais un phénomène naturel. Selon la situation météorologique, ces fentes peuvent se refermer quasi-intégralement. De plus, ces fentes de sécheresse, qui apparaissent dans le bois dans le sens de la longueur, n'exercent aucune influence sur la solidité et la résistance du matériau. Autrement dit, les propriétés statiques ne sont pas affectées.

- it -

Egredi clienti,

- Prima del montaggio leggete con cura le presenti istruzioni al fine di evitare errori di montaggio o danni.
- **IMPORTANTE !**
Controllate subito con l'ausilio della lista di imballaggio che il prodotto sia stato fornito completo e senza danni.
- Vi preghiamo di conservare la lista di imballaggio solo alla scadenza del periodo di garanzia. Questa lista serve per controllare la completezza della fornitura e deve essere conservata insieme allo scontrino. Con l'ausilio della lista è possibile risolvere eventuali reclami. I numeri di posizione della lista di imballaggio non corrispondono con i numeri di posizione delle seguenti istruzioni di montaggio.
- Raccomandiamo di eseguire il montaggio in 2 persone.
- Per scongiurare eventuali incidenti tenere lontano i bambini dal luogo di montaggio.
- A seconda del basamento esistente, va scelta un'adeguata forma di installazione dei bulloni di ancoraggio. (Tale materiale non è incluso nella partita)
- Ci riserviamo di apportare modifiche ai fini del progresso tecnologico. Per tale motivo è possibile che nelle rappresentazioni vengano a crearsi lievi differenze.
- Non gettare via il materiale di imballaggio! La carta, il cartone normale e ondulato cosiccome gli imballaggi in plastica devono essere smaltiti negli appositi contenitori di raccolta.

RACCOMANDAZIONI

- Per evitare danni agli elementi in legno si raccomanda di preforare tutti i punti di avvitaggio a vite! Il presente simbolo richiama la vostra attenzione su tale particolare nel corso delle istruzioni:



- Il legno è un prodotto naturale. Differenti irregolarità cromatiche, la ramificazione e la crepatura sono da considerarsi normali e non hanno alcuna influenza sulla statica.

Protezione legno

Per conservare nel corso degli anni lo splendido aspetto del vostro prodotto weka, vi consigliamo una verniciatura protettiva al più tardi ad un anno dall'assemblaggio.

Questa verniciatura protettiva migliora l'estetica del prodotto, costantemente soggetto all'azione usurante degli agenti atmosferici e dei raggi solari.

Per questo motivo, è necessaria una regolare verniciatura, in conformità alle direttive della casa produttrice.

UTENSILE

Prima di iniziare con il montaggio tenere a portata di mano i seguenti utensili.

Non compreso nella fornitura!

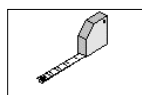

metro a nastro

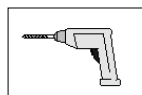

trapano



avvitatore elettrico

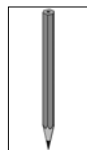

Matita



Livella ad acqua

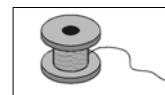

filo

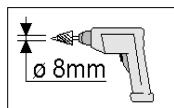

trapano conico

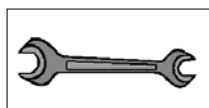

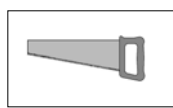

chiave



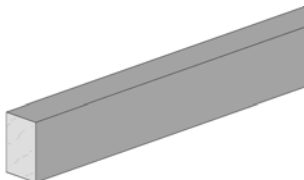
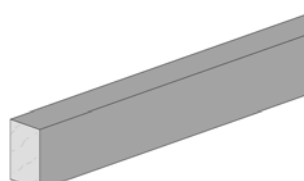
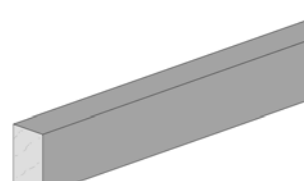
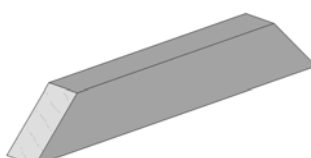
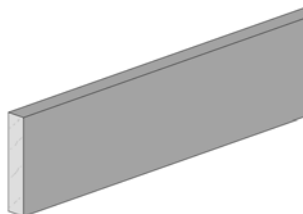
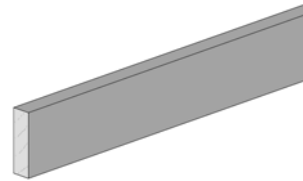

Sega

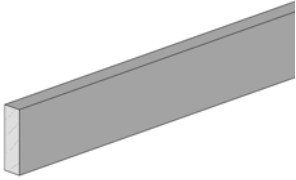
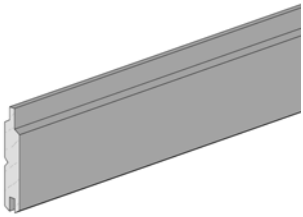
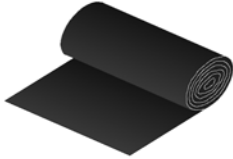
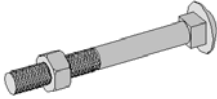
Si raccomanda di controllare periodicamente tutti i collegamenti a vite e di riserrarli all'occorrenza. Questo prodotto è prevalentemente realizzato con legno massiccio e poiché nel materiale legno si tratta di un prodotto naturale, in seguito a condizioni atmosferiche estreme, in particolare durante i lunghi periodi estivi, non è da escludere una formazione di fessure di essiccamento. Queste fessure di essiccamento non sono in nessun caso un difetto di qualità, bensì un fenomeno naturale. A seconda delle condizioni atmosferiche queste fessure possono di nuovo chiudersi, lasciando soltanto uno spiraglio minimo. Inoltre, queste fessure di essiccamento, che si formano in senso longitudinale sul legno, non hanno alcun influsso sulla stabilità e sul carico del materiale. Ciò significa che non vengono in alcun modo pregiudicate le caratteristiche statiche.

Pos	Bild	Abmessung	Stück	
			663.1303.00.00	663.1306.00.00
①		40 / 60 / 1450	2	2
②		40 / 60 / 1550	2	2
③		40 / 60 / 1250	4	4
④		40 / 60 / 300	2	2
⑤		18,5 / 90 / 300 18,5 / 90 / 600	21 -	- 21
⑥		18,5 / 60 / 350 18,5 / 60 / 650	2 -	- 2

Pos	Bild	Abmessung	Stück	
			663.1303.00.00	663.1306.00.00
7		18,5 / 60 / 1288	1	1
8		18,5 / 96 / 350 18,5 / 96 / 650	15 -	- 15
9		1,5m ²	1	1
10		M8 x 100	8	8
11		8 mm	8	8
12		5,0 x 80	2	2

Pos	Bild	Abmessung	Stück	
			663.1303.00.00	663.1306.00.00
13		4,0 x 60	6	6
14		3,5 x 35	170	170
15		2,0 x 16	90	90

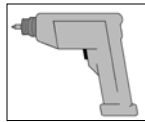
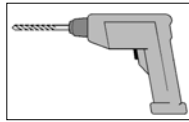
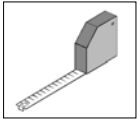
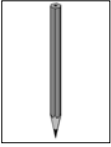

1



Abbildung Art.-Nr.: 663.1306...

2



Abbildung Art.-Nr.: 663.1306...

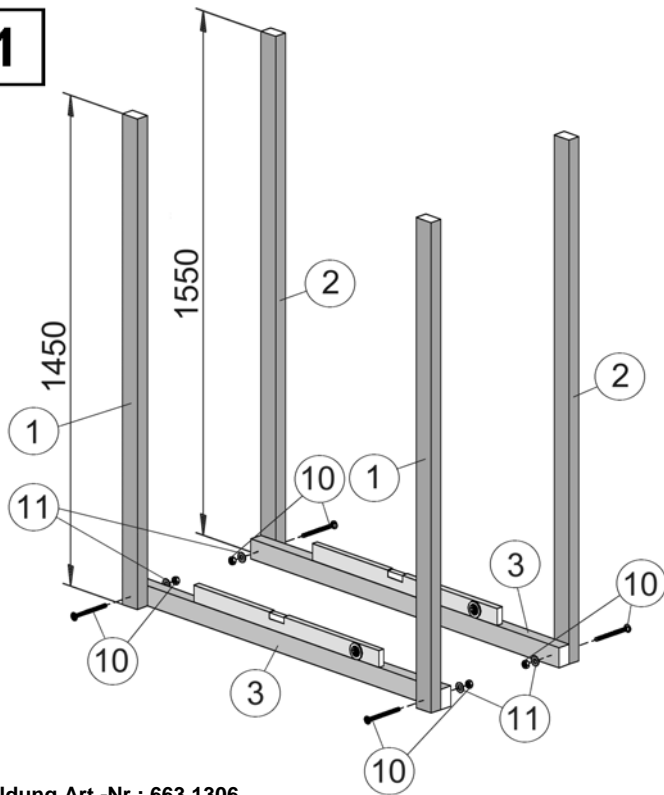

3

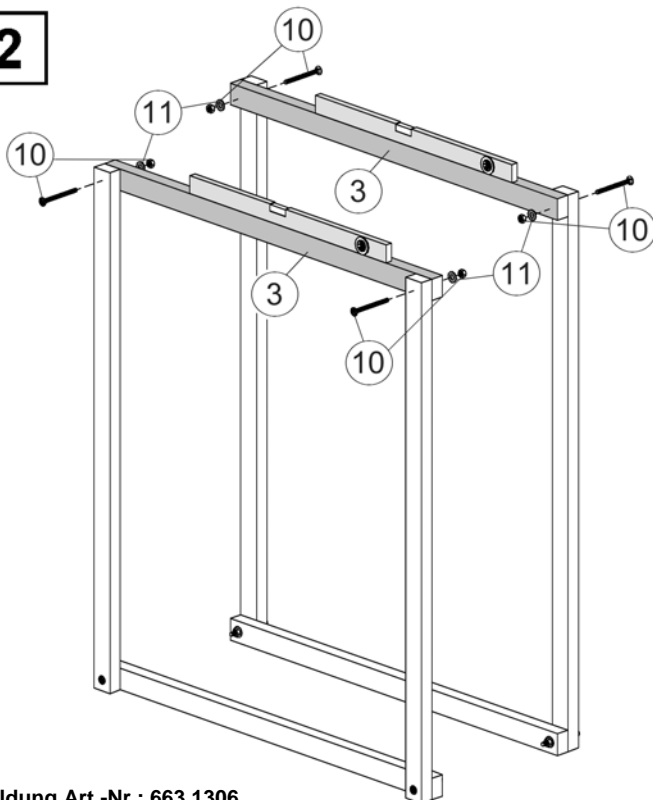
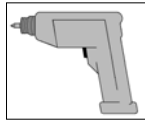
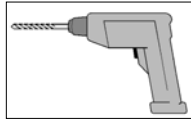
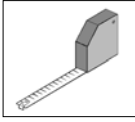
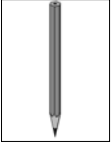

Abbildung Art.-Nr.: 663.1306...

4



Abbildung Art.-Nr.: 663.1306...

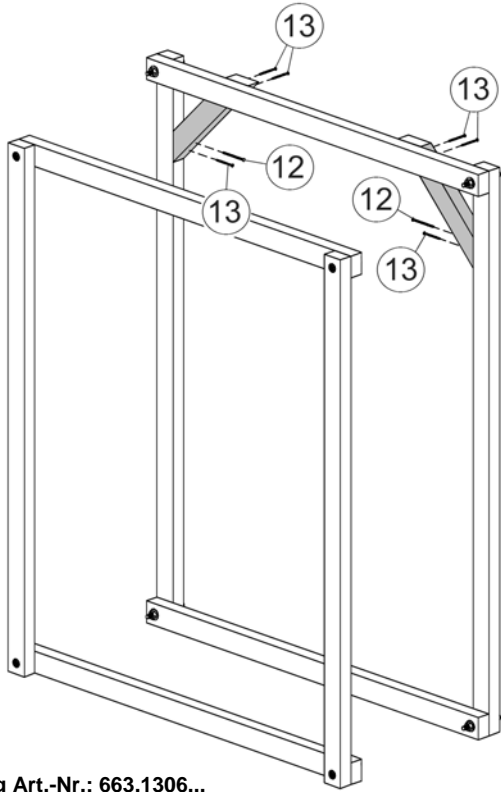



5

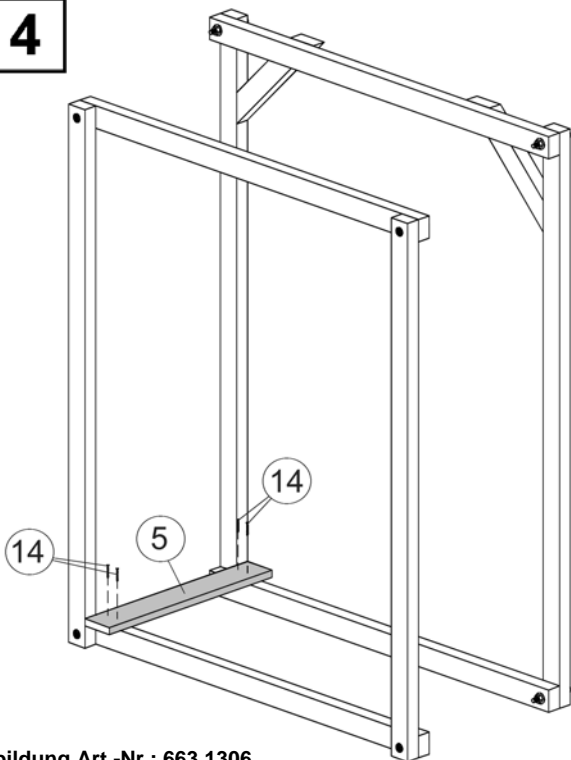
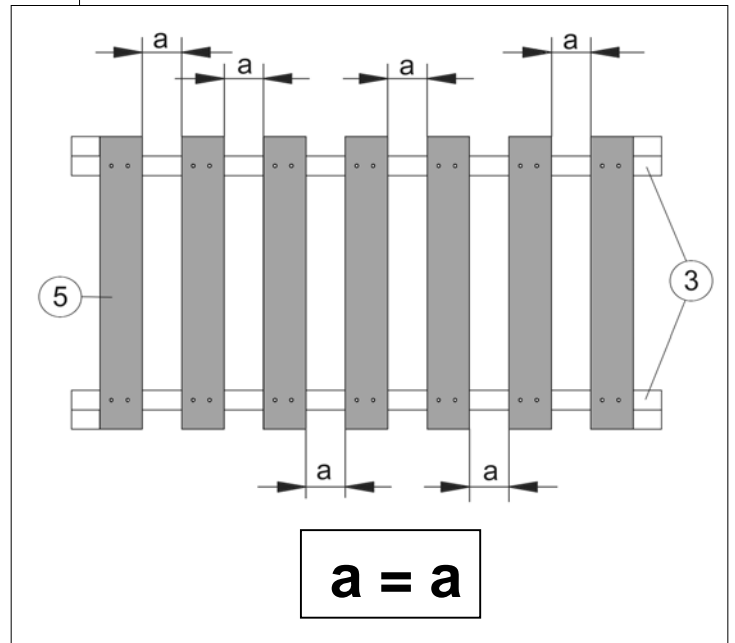
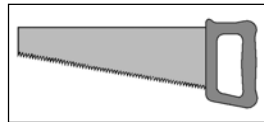
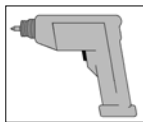
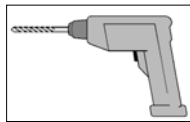
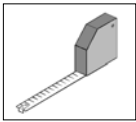
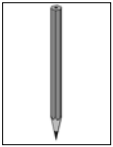

Abbildung Art.-Nr.: 663.1306...

6



Abbildung Art.-Nr.: 663.1306...

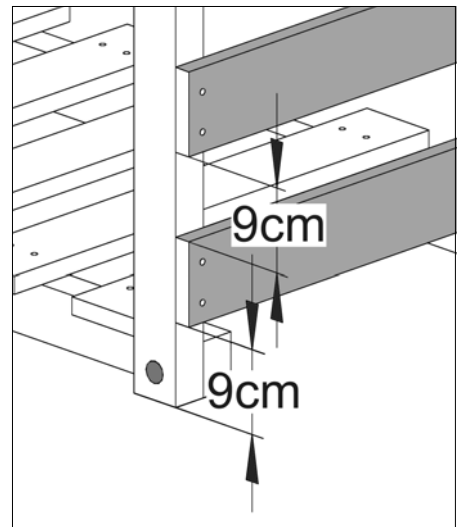
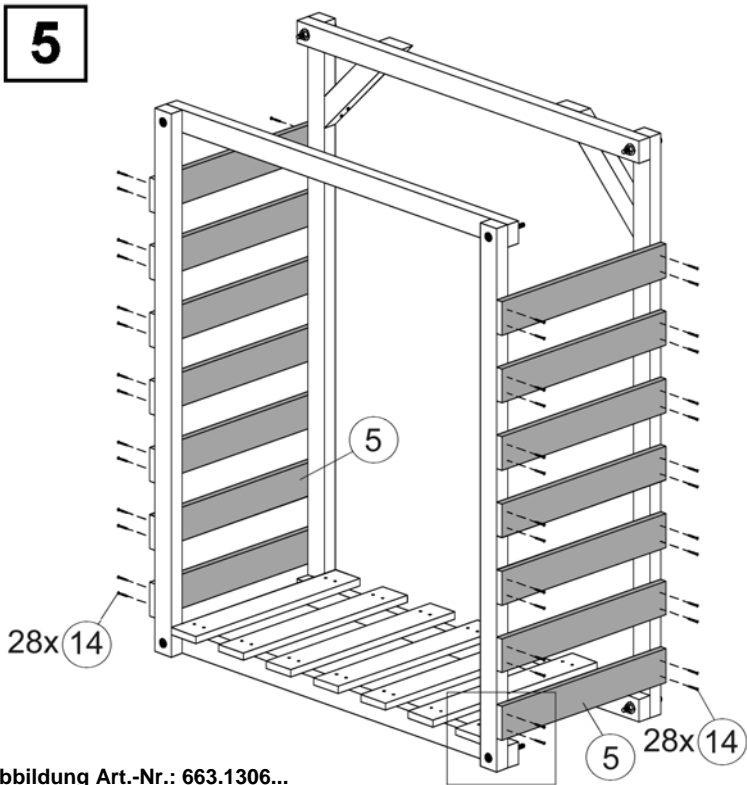
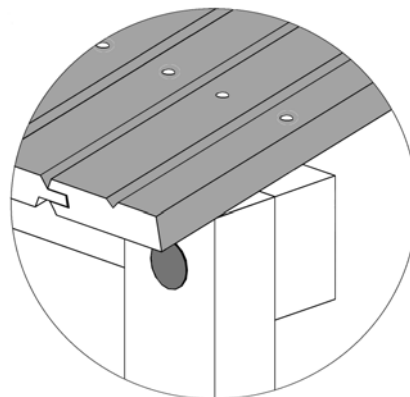
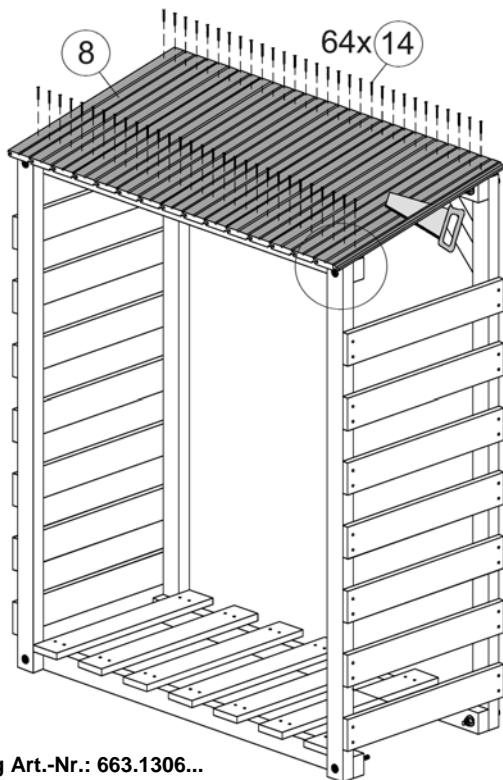
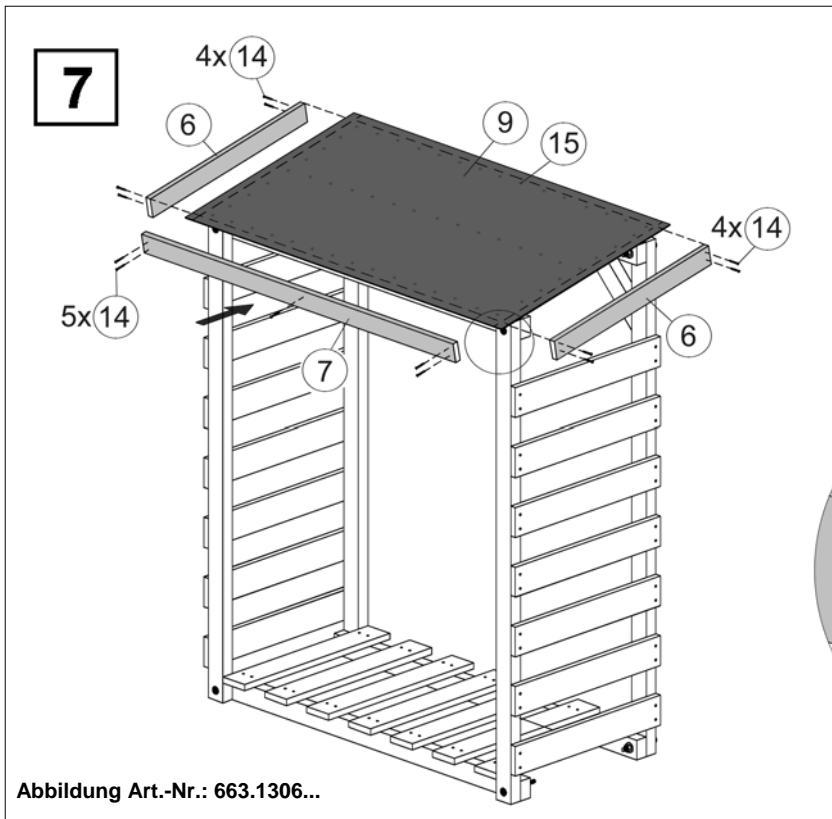
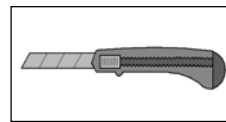
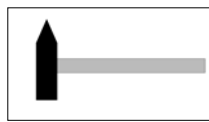
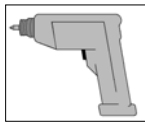
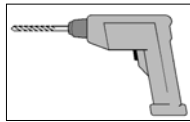
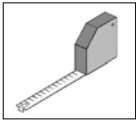
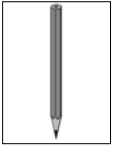

weka Holzbau GmbH, Johannesstr. 16
D-17034 Neubrandenburg
Tel.: 0395 42908-0
Fax: 0395 42908-83
E-Mail: Info@weka-Holzbau.com

MA Art.-Nr.: 800.0286.09.09