

Technische Daten Lyon A

Wandaußenmaß: 190 x 190 cm

Bohlenstärke: 28 mm



Kontrolliert durch:

Achtung: Alle angegebenen Maße sind ca.-Maße!

3D-Ansicht Lyon A

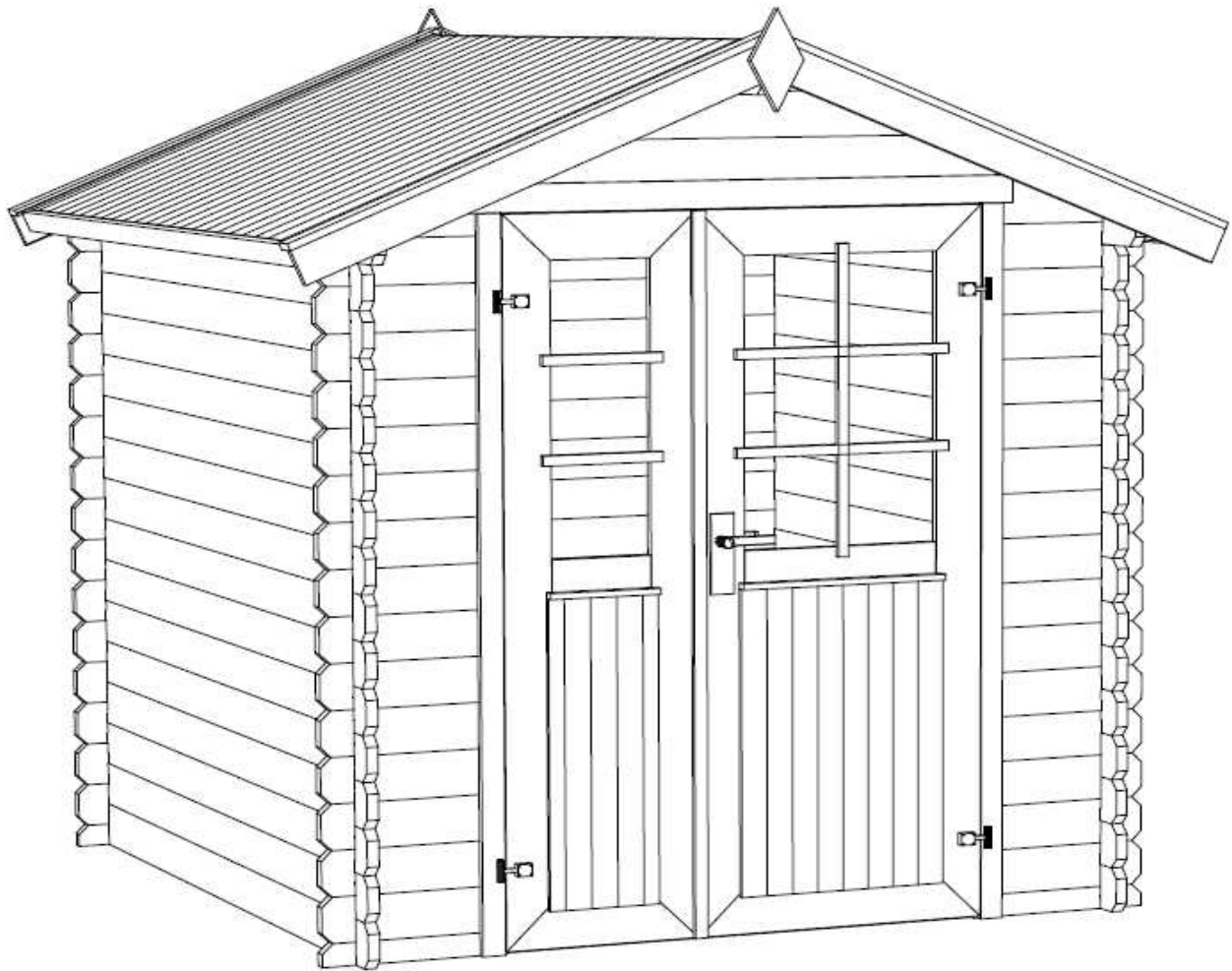



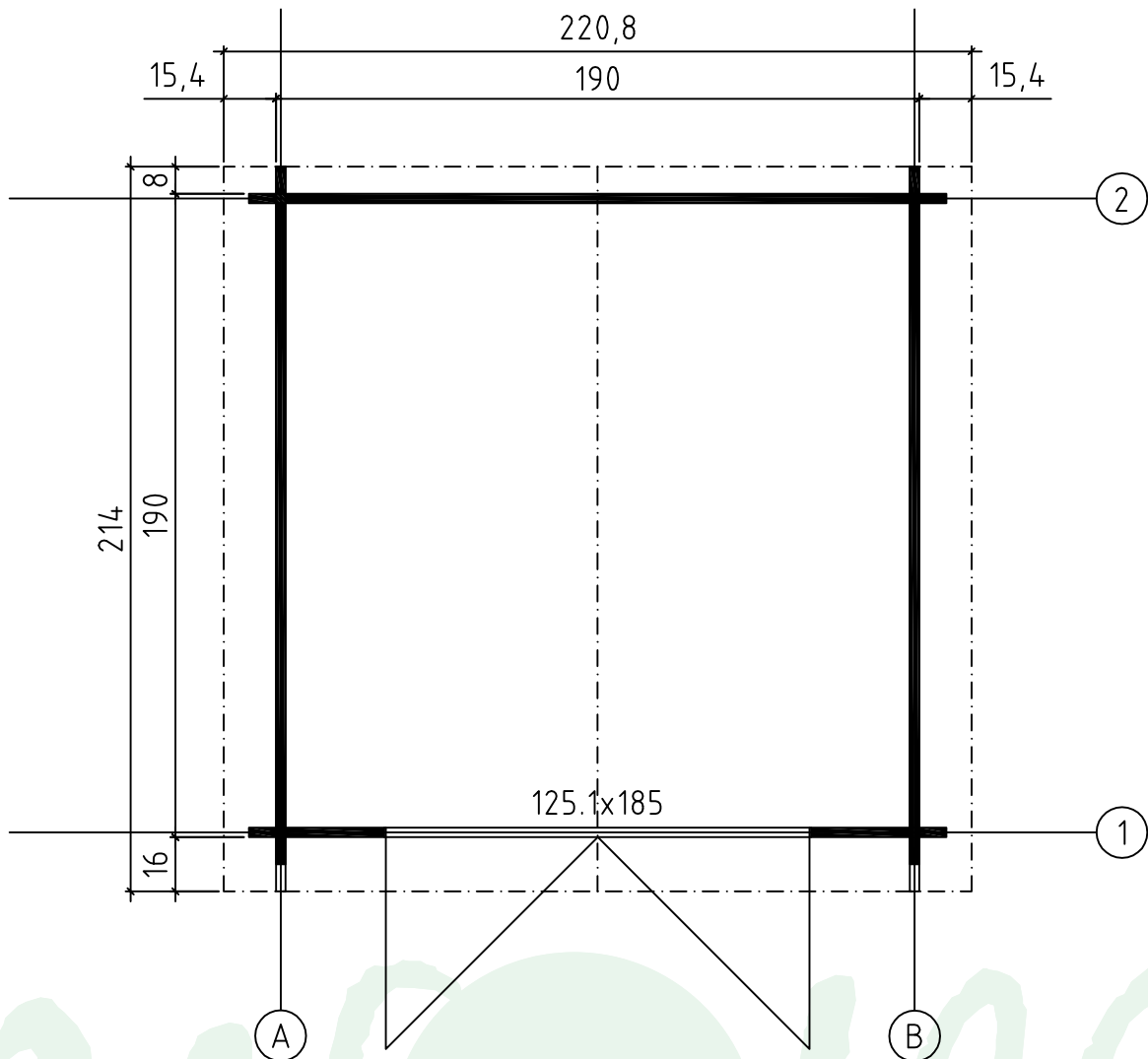







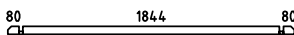
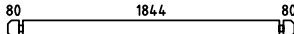
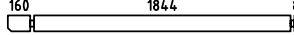
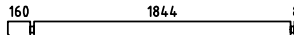
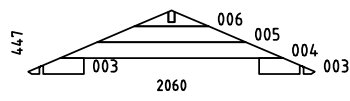
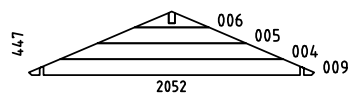
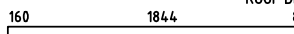
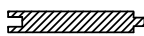

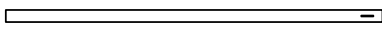
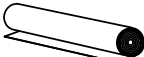
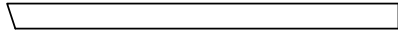
Grundriss Lyon A

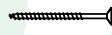



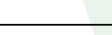







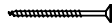

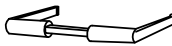

Teileliste 1

Lyon A

Pos		Q.	P. (mm)	L. (mm)
001		2	28x57	400
002		30	28x114	400
007		1	28x57	2060
008		45	28x114	2060
010		1	28x120	2140
011		1	28x120	2140
W1-1		1		
W2-1		1		
PR1	 ROOF BEAM - DACHBALKEN - PANNE DE TOIT	1	44x120	2140
	ROOF BOARDS - DACHBRETTER - VOLIGES 	48	90x15	1200
	ROOFING FELT FILLET - DACHPAPPENLEISTE - BAGUETTE DE FIXATION DU FEUTRE BITUMEUX 	4	18x58	1250
	EAVES BOARD - TRAUFBRETT - BANDEAU DE TOIT 	2	18x58	2140
	STORM PROTECTION - STURMLEISTE - LATTE ANTI-TEMPETE 	4	22x45	1760
	ROOFING FELT - DACHPAPPE - FEUTRE BITUMEUX 	3		2240
	GABLE MOULDING - GIEBELLEISTE - - PLANCHE DE RIVE 	4	18x120	1250
HS57	SCREW FOR DOOR LOCK - SCHRAUBEN FÜR TÜRSCHLOSS - VIS POUR SERRURE DE PORTE 	2	2.5x25	
	SCREW FOR GABLE SEGMENT - SCHRAUBEN FÜR DECKBLATT - VIS POUR FIXATION LOSANGE DE FINITION 	4	3.5x35	
HS22	SCREW FOR FIXING DOOR TO THE WALL - SCHRAUBE ZUR BEFESTIGUNG TÜR- ZARGE MIT WAND - VIS DE FIXATION DORMANT DE PORTE 	2	3.5x50	
HS59	SCREW FOR DOORSTEP - SCHRAUBEN FÜR SWELLE - VIS DE FIXATION DU SEUIL DE PORTE 	3	3x30	
	SCREW FOR FILLET - SCHRAUBE ZUR BEFESTIGUNG TÜRLEISTE - - VIS D'ASSEMBLAGE DU CADRE DE PORTE 	5	3x30	
	SCREW FOR FIXING BOLT HINGE - SCHRAUBE FÜR TÜRRIEGEL - - VIS DE FIXATION POUR CHARNIÈRES ET GONDS DE PORTE 	16	4.5x25	
	SCREW FOR FIXING BOLT HINGE - SCHRAUBE FÜR TÜRRIEGEL - - VIS DE FIXATION POUR CHARNIÈRES ET GONDS DE PORTE 	12	4.5x35	
	SCREW FOR DOOR JAMB - SCHRAUBE FÜR TÜRRAHMEN - VIS DE FIXATION POUR MONTANT DE PORTE 	2	4x60	

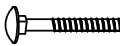
Teileliste 2

Lyon A

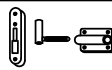
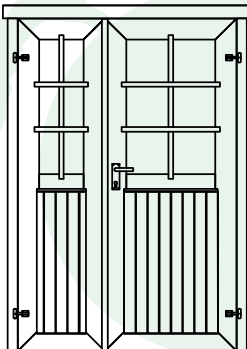
Pos		Q.	P. (mm)	L. (mm)	
	SCREW FOR DOOR JAMB - SCHRAUBE FÜR TÜRRAHMEN - VIS DE FIXATION POUR MONTANT DE PORTE		2	5x90	
	HAMMER BLOCK - SCHLAGHOLZ - CALLE DE FRAPPE 28mm		1		
	ROOFING NAILS FOR ROOFING FELT - NÄGEL FÜR DACHPAPPE - - POINTE DE FIXATION POUR FEUTRE BITUMEUX		64	2.1x17	
	DOOR LOCK - TÜRSCHLOSS - SERRURE DE PORTE		1		
	DOOR HANDLE FITTINGS - TÜRGRIF - GARNITURE DE POIGNÉE DE PORTE		1		
	DOOR HANDLE FITTINGS - TÜRGRIF - SET DE GARNITURES DE SERRURE DE PORTE		1		
	STICKER FOR LOCK - SCHLIEßBLECH FÜR TÜRSCHLOSS - GACHE DE PORTE		1		
	SCREW FOR GABLE MOULDING - SCHRAUBEN FÜR GIEBELLEISTE - - VIS DE FIXATION POUR PLANCHE DE RIVE		16	3.5x50	
	SCREW FOR EAVES BOARDS - SCHRAUBEN FÜR TRAUFBRETTER - - VIS DE FIXATION POUR BANDEAU DE TOIT		10	4x40	
	LATCH BOLT FÜR DOUBLE DOOR - TORRIEGEL - LOQUET POUR DOUBLE PORTE		2		
	GABLE SEGMENT - DECKBLATT - LOSANGE DE FINITION		2		
	NUT FOR STORM PROTECTION - SCHRAUBENMUTTER FÜR STURMLEISTE - - ÉCROU POUR LAME ANTI-TEMPETE		8		
	BOLT FOR STORM PROTECTION - BOLZEN FÜR STURMLEISTE - - VIS POUR LAME ANTI-TEMPETE		8		
	WASHER FOR STORM PROTECTION - DICHTSCHEIBE FÜR STURMLEISTE - - RONDELLE POUR LAME ANTI-TEMPETE		8		
	ZN NAIL FOR ROOFING FELT FILLET - ZN NÄGEL FÜR DACHPAPPENLEISTE - - POINTE POUR BAGUETTE FIXATION FEUTRE BITUMEUX		16		
	ZN NAIL FOR ROOF - ZN NÄGEL FÜR DACHBRETTER - POINTE POUR TOIT		104		
	MALE BOLT HINGE FOR DOOR - TÜRRIEGEL - PARTIE MALE DE CHARNIERE DE PORTE		4		
	DOOR - TÜR - PORTE 1251x1850	TUK.2.056.SVP.M28b	1		
					

Wandpläne Lyon A

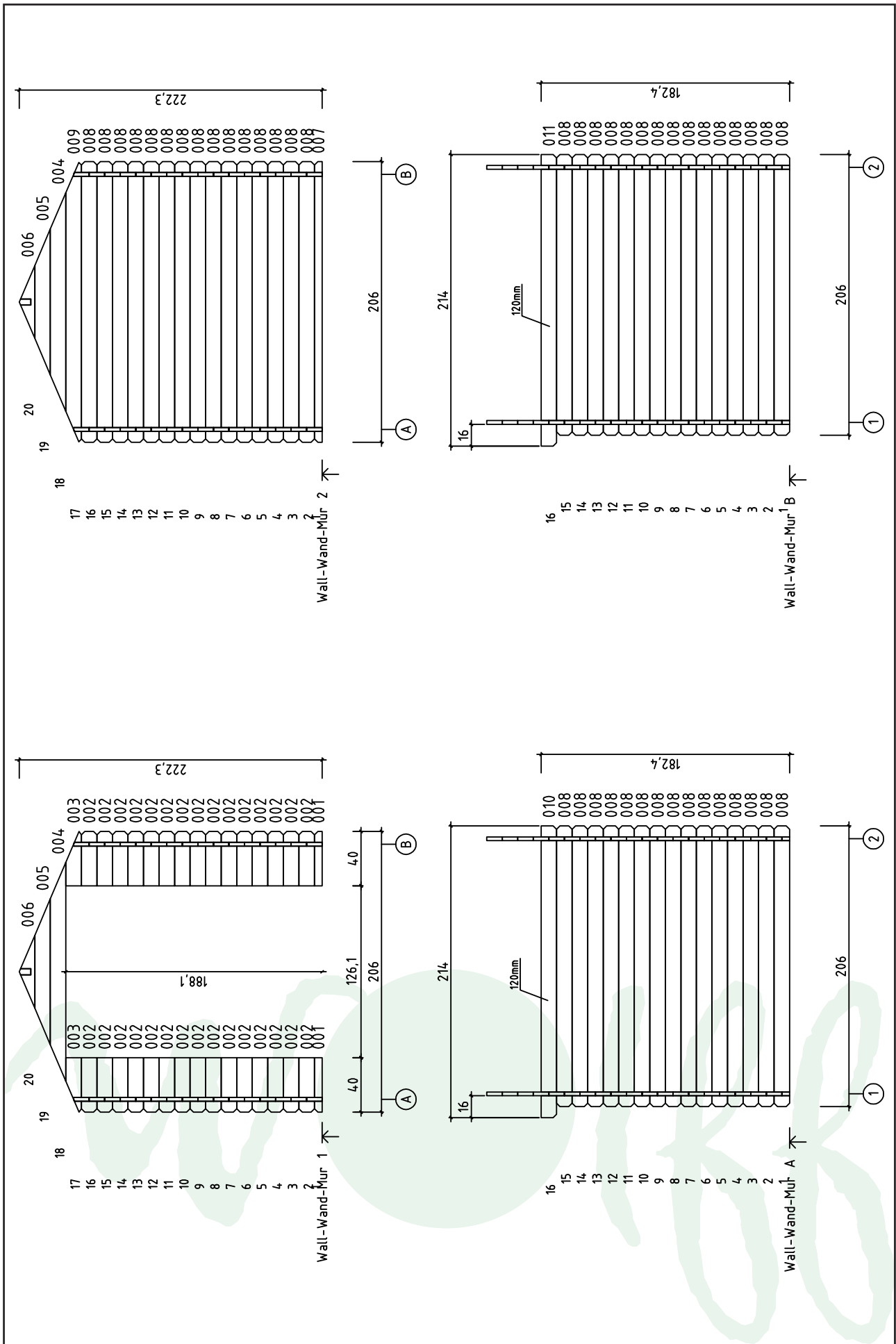

Detail 1 Lyon A

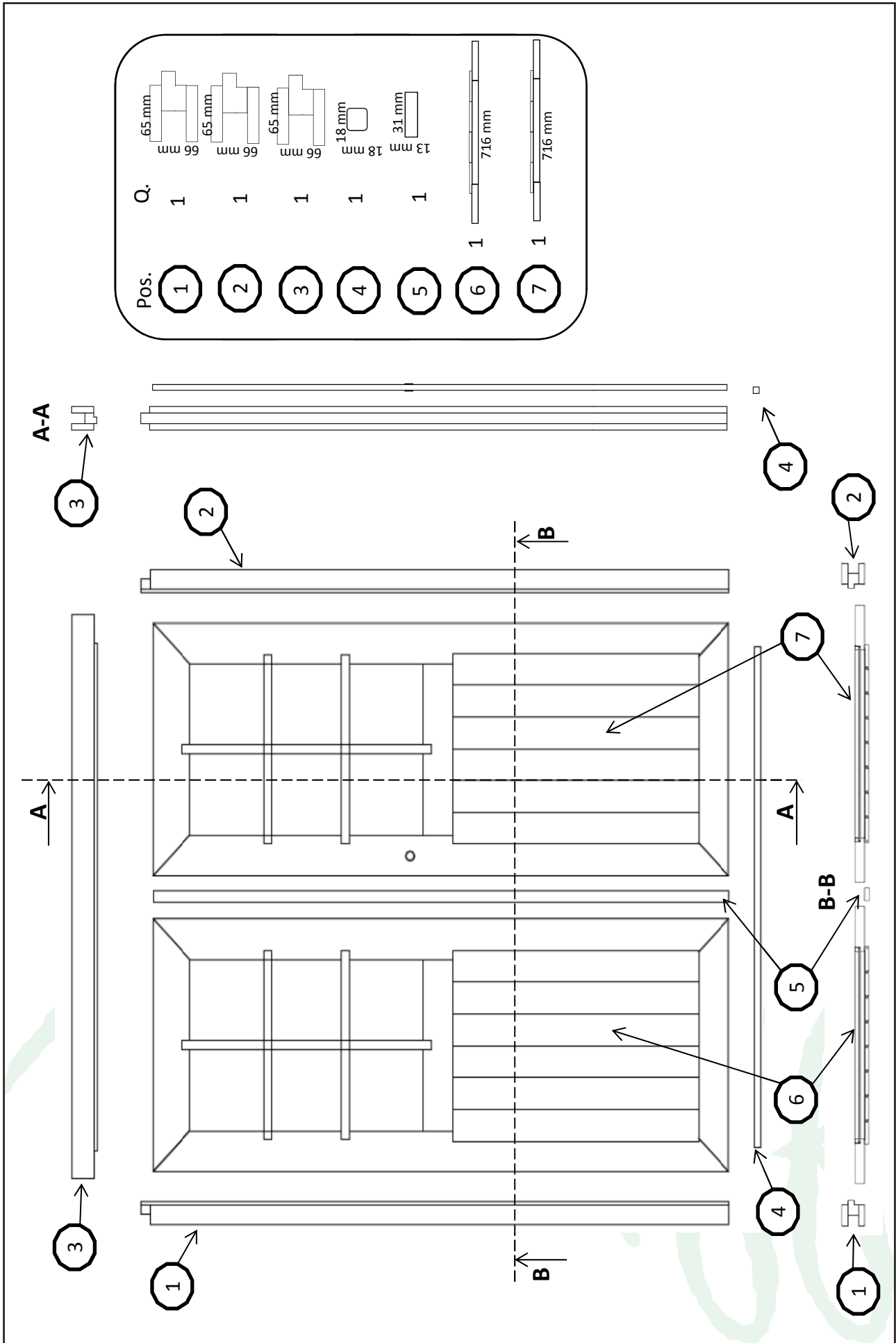

Detail 2 Lyon A

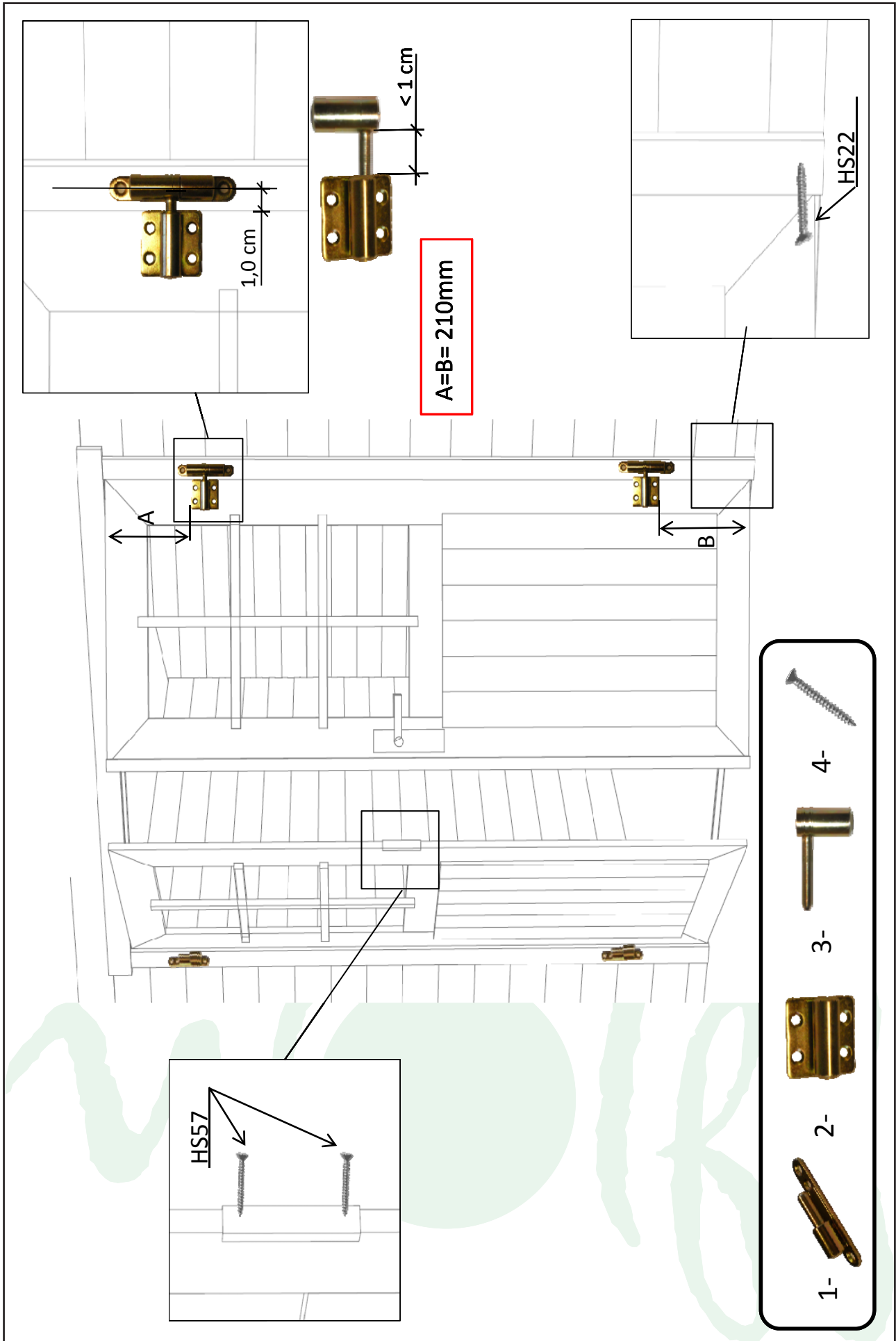

Detail 3 Lyon A

